

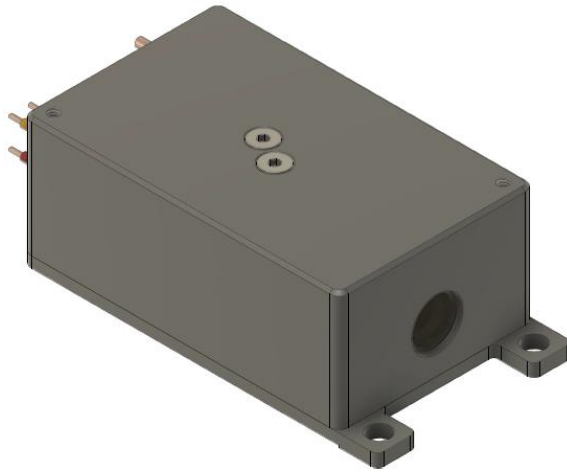

RANGER laser



User manual





Contents:

1. Introduction.....	4
2. Safety information	5
3. Laser head.....	6
4. Laser driver	8
4.1 Connectors.....	9
4.2 TRIGGER IN or TTL modulation.....	9
4.3 Interlock button.....	9
5. SF6090 laser driver and Maiman BenchSoftsoftware user manual:.....	10
5.1 How to get started?.....	10
5.2 How to get finished?	13
5.3 Trigger mode.....	13
6. Digital control.....	14
6.1 The format of the command to set the value (P-type);.....	14
6.2 The format of the command to get the value (J-type).....	16
6.3 The format and codes of errors	17
6.4 Available parameters and its description	18
7. Digital control description (extended).....	20
7.1 Text-plain mode	22
7.2 Possible problems	23
7.3 Binary mode	23



Copyright Optogama. All rights reserved.

No part of this manual may be reproduced, transmitted in any form without the permission of Optogama.

Claims will not be accepted, and warranty repair will not be carried out in case of improper use, incorrect service and maintenance not according to product instructions. Warranty claim shall not be accepted if there are any signs of:

- Non-authorized alteration
- Disassembling of the device
- Mechanical or any external damage
- If warranty term has expired
- Serial number of the product is missing

Due to constant development of our products we reserve the right to make changes in the production line without further notice. Up-to-date information is available at our website www.optogama.com. If there are any further questions, please contact us.

Optogama is not liable for damage or injury resulting directly or indirectly from use of this product for anything other than its intended purpose.

The RANGER laser is intended for industrial and scientific use only. If there are any other electrical devices connected to or used in conjunction with the laser, all legal regulations and technical standards that are applied to those devices must be observed as well.

For any technical assistance and consultation please contact your local dealer or directly <mailto:sales@optogama.com>.



1. Introduction

The package you received contains all the necessary components to run the laser. This manual is intended to provide detailed information on how to operate the laser properly. The detailed views of each part with descriptions and appearance you can find in section 3 and 4 (Laser head and Laser driver)

Package contents:

- 1535 nm diode pumped passive q-switched RANGER laser.

Optional:

- Laser driver
- Power supply
- Connecting wires
- Collimator
- Collimator mount



2. Safety information



To ensure safety, please read this manual carefully before operating the device. Complete everything step by step. In case of any uncertainties contact the vendors.



Exposure to laser radiation may be harmful. Always wear suitable laser goggles to protect your eyes when working with the laser. All apertures which can emit laser light more than levels which are considered safe are identified with laser beam warning stickers.



High voltages and currents inside the laser housing, do not open it. Perform the connections exactly as described or else you can damage the computer and/or the electronics of the laser.



3. Laser head

Laser head is a compact (dimensions: 61,5 x 30,6 x 20,5 mm) lightweight box. The laser head's appearance in different views is provided below. Laser emission aperture is identified with simple window with antireflective coating. Contacts of the laser diode, internal photodiode and NTC are located at the back of laser head.

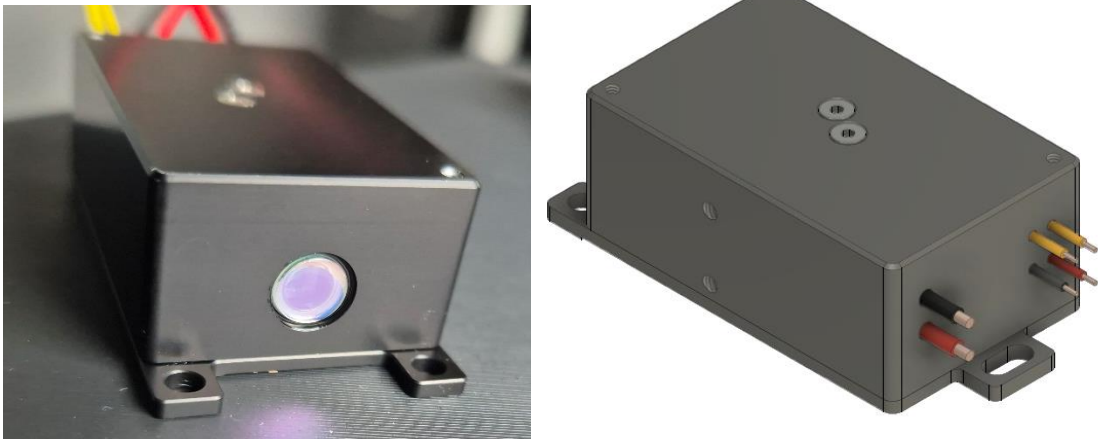

Figure 1. Front view and wiring

Left side		Right side	
Black, AWG 16	Laser diode, negative	Black, AWG 24	Photodiode, cathode
Red, AWG 16	Laser diode, positive	Red, AWG 24	Photodiode, anode
		Yellow, AWG 24	NTC thermistor, 10k, polarity is not important
		Yellow, AWG 24	

IMPORTANT: Please note the polarity for laser diode wires.



4.1 Collimator

Laser can be equipped with a collimator fixed to laser head (see figure 2) or the collimator can be provided separately to be mounted by the user (figure 3). Beam divergence after the collimator can be slightly adjusted by changing distance between laser output window and collimator input window. Factory mounted collimators typically have <math><0.5\text{ mRad}</math> divergence angle (full).

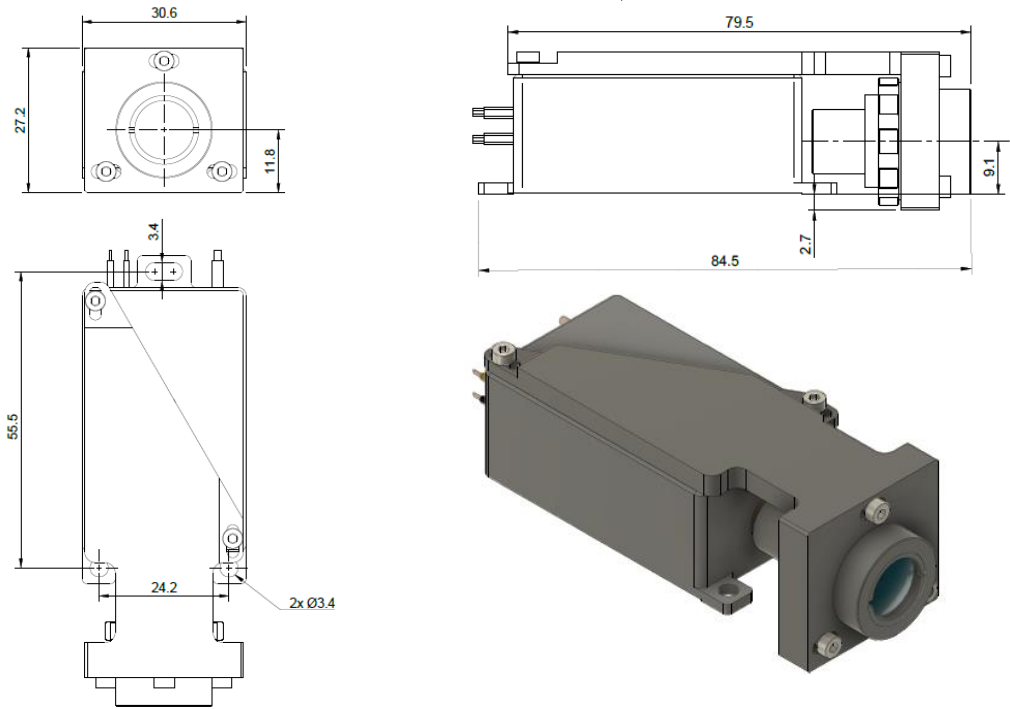

Figure 2. laser head with factory attached collimator.

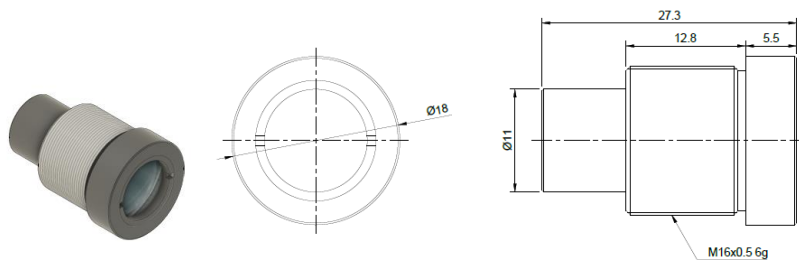

Figure 3. Collimator as separate component (not mounted).



4. Laser driver

The driver of the RANGER laser is shown in Figure 4.



Figure 4. Laser driver.

The dimensions of the driver are: 12.8 x 8.3 x 4.8cm. There are the Trigger and RS232 connectors on the front panel of the driver (Figure 4.2). On the back of the driver box there are power supply input and the laser diode output terminals. The notes with polarity and Input, Output locations are engraved on the box near the terminals (Figure 4.3).



4.1 Connectors

The driver is connected via RS-232 DB-9 connector. Pins which are used are marked in Fig.5.

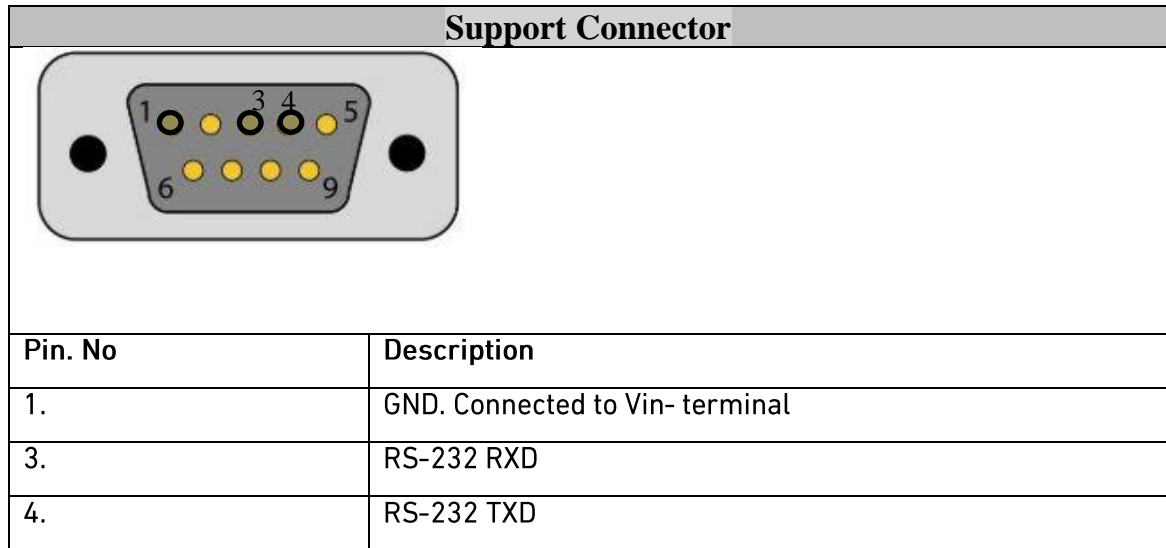

Figure 5. RS2323 DB9 connector

4.2 TRIGGER IN or TTL modulation

The RANGER laser can be modulated by output source. For this purpose, driver has TRIGGER IN connector. If you use trigger mode, laser will be activated by TTL high- level (>3.3V). The trigger voltage threshold is 5 V. Operation of trigger mode in software is described in Section 5.5.

4.3 Interlock button

There is the INTERLOCK button in the front panel near the connectors. It helps to manage laser driver not only by computer, but also physically by pushing the button in or out.



5. SF6090 laser driver and Maiman BenchSoft software user manual:

Before switching on your driver, read this manual thoroughly.

Please note: Do not ground any lead of the output. This will immediately destroy the driver and the laser diode! Please keep the laser diode contacts shorted until they are connected to V_{out-} and V_{out+} driver terminals. The contact with “-” sign or black color wire should be applied to V_{out-} and contact marked with the “+” or red color wire to V_{out+} terminal.

5.1 How to get started?

1. Unpack your driver and laser head;
2. Apply the laser diode contacts to laser driver OUTPUT. The contacts with black color wire should be applied to V_{out-} and the red color wire to V_{out+} terminals.
3. Apply the driver to the power supply voltage to (12DC INPUT) “-” and “+” terminals. Please note polarity.
4. Open the program Maiman BenchSoft. Initial window of the software is shown in Figure 6.

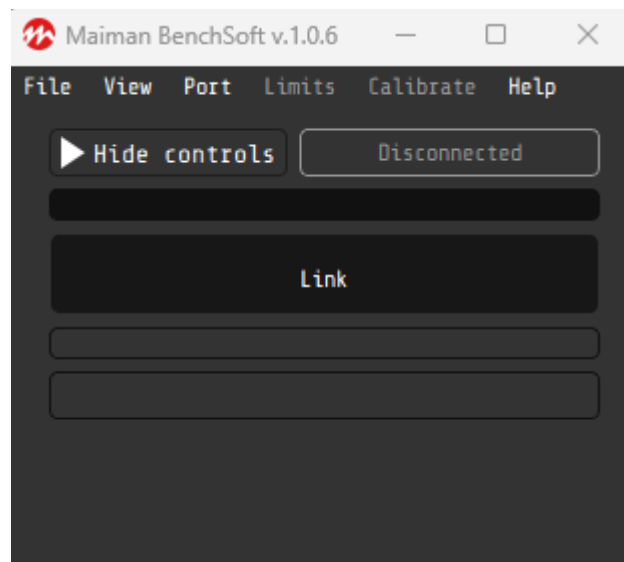

Figure 6. MAIMAN BENCHSOFT software start up window



- To start the program you should firstly choose correct port in Select Port submenu:

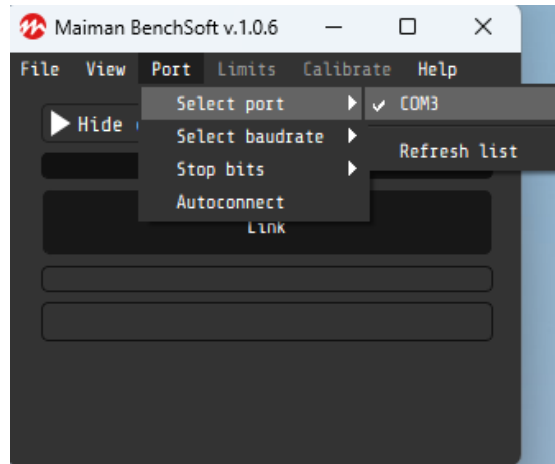

Figure 7. MAIMAN BENCHSOFT software port selection field

- Click on Disconnected button. Software connects to driver unit and software window changes. See the Figure 8.

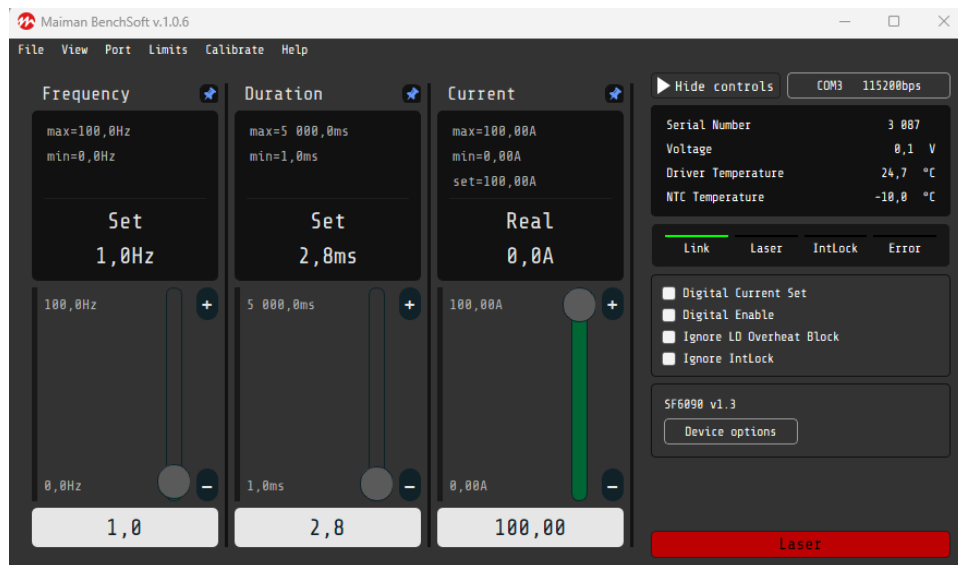

Figure 8. MAIMAN BENCHSOFT software program settings

- When you connect to the driver unit, pumping parameters are set automatically. Please check if the parameters are set correctly.

IMPORTANT: Refer to laser test report or label on the laser unit for correct laser driver parameters.



- After parameters are set properly, please activate Device state flags panel which is shown below in Figure 9. In order to activate, tick the checkboxes to “Digital Current Set”; “Digital Enable” and “Ignore IntLock”.

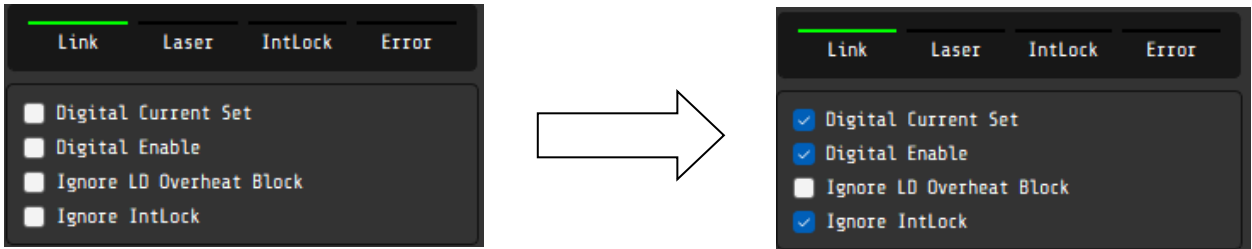

Figure 9. MAIMAN BENCHSOFT Device state flags panel

- In case you use the INTERLOCK button to control laser driver, you don't need activate “Ignore IntLock”. You should tick the checkbox buttons near “Digital Current Set”; “Digital Enable” and push physical INTERLOCK button on the driver unit. See

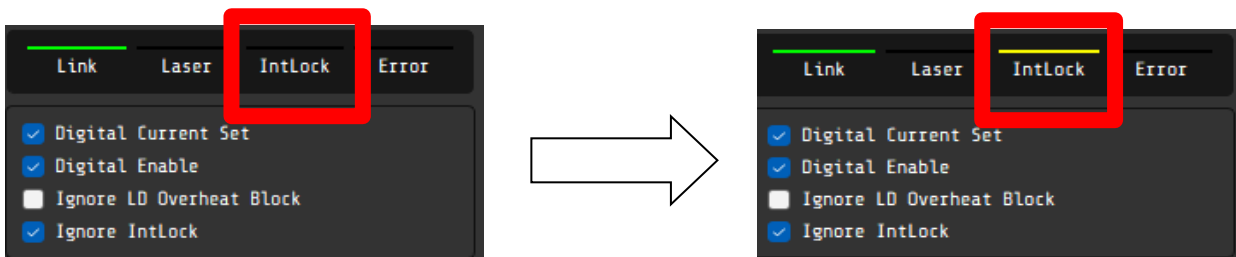

Figure 10. MAIMAN BENCHSOFT change state panel using Interlock

Please pay attention to the “IntLock” indicator in software. When the indicator is yellow, the Interlock button is switched off.

- When all the parameters are set to correct ones, click Laser button in the right bottom corner of the software window and driver starts running.

Please note: to change the desired value of the parameter, please deactivate the laser by clicking Laser button and activate once again when your parameter is changed. Do not change driver parameters while driver is in active state.



OPTOGAMA

5.2 How to get finished?

1. If you want to exit the program, deactivate the driver by clicking Laser button in the right bottom corner of the software window.
2. Click on your connected port number in right top corner of the software window to disconnect from the driver unit.
3. Then click File -> Exit or just click Close button.

5.3 Trigger mode

1. If you have used the driver in direct mode before, please disconnect driver and connect it again to software.
2. Please check the trigger signal characteristics from the output source before connecting directly to the driver. The signal from your output source should be square. For the duration of the signal refer to "Pump duration" value which is given in test report of specific unit or on the label of the unit. E.g., if pump duration is 3.0ms, duration of the signal should also be 3.0ms which is equal to 0.3% of duty cycle. Connect your output source.
3. After that, in Device state flags panel you should activate two buttons: "Digital Current Set" and "Ignore IntLock" (if you don't use INTERLOCK button) as it shown in Figure 11.

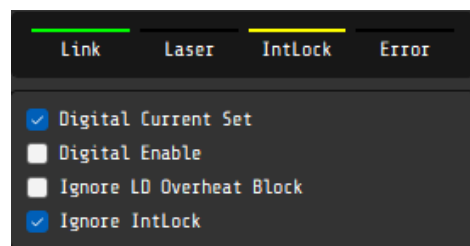

Figure 11. MAIMAN BENCHSOFT software setup for TTL modulation (without INTERLOCK button)

4. If you use the INTERLOCK button, you should only activate "Digital Current Set" and push the INTERLOCK button in.

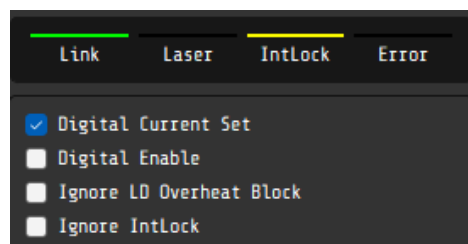

Figure 12. MAIMAN BENCHSOFT software setup for TTL modulation (with INTERLOCK button)

IMPORTANT: INTERLOCK button has to be OFF (not lasing) before turning external trigger OFF. Otherwise laser diode or laser crystal damage may occur.



6. Digital control

If you have special requirements, you can use the digital control guide which we provide in this section.

When the input voltage applied the driver is always in “analogue current set, external enable and allowing interlock” state. Any other state should be set any time after powering the driver if needed.

Default serial port settings:

Baud rate	Data bits	Stop bits	Parity	Flow control
115200	8	1	none	none

Data exchange between the driver and the PC is only initiated by the PC. All commands are sent in plain text format. All commands are sent with prefixes. Number of commands follows the prefix without any symbols. If there is the value after the command, they separate with “space” symbol. The command ends with “carriage return” symbol.

6.1 The format of the command to set the value (P-type);

Number of byte	Value	Comment
1	P (50h)	Set prefix
2-5	Number of the parameter	Hex-number of the parameter. For example, 0100h
6	'space' symbol (20h)	
7-10	New value of the parameter	Hex-value of the parameter. For example, 0000h
11	'return carriage' symbol<CR> (0Dh)	End of the command



The device does not respond to P-type commands by default. (see section “the protocol extension”)

You can request the value of parameter by the J-type command. The device will return a value of requested parameter.

Number of byte	Value	Comment
1	J (4Ah)	Request prefix
2-5	Number of the parameter	Hex-number of the parameter. For example, 0100h
6	'return carriage' symbol<CR> (0Dh)	End of the command

The format of the response

Number of byte	Value	Comment
1	K (4Bh)	Response prefix
2-5	Number of the parameter	Hex-number of the requested parameter
6	'space' symbol (20h)	
7-10	Returned value of the parameter	Hex-value of the parameter
11	'return carriage' symbol<CR> (0Dh)	End of the command



6.2 The format of the command to get the value (J-type)

Number of byte	Value	Comment
1	J (4Ah)	Request prefix
2-5	Number of the parameter	Hex-number of the parameter. For example, 0100h
6	'return carriage' symbol<CR> (0Dh)	End of the command

The format of the response

Number of byte	Value	Comment
1	K (4Bh)	Response prefix
2-5	Number of the parameter	Hex-number of the requested parameter
6	'space' symbol (20h)	
7-10	Returned value of the parameter	Hex-value of the parameter
11	'return carriage' symbol<CR> (0Dh)	End of the command

If the device could not recognize a command, it returns an error message with an error code.



6.3 The format and codes of errors

Error (returned command)	Reasons (one or few)
E0000	<ol style="list-style-type: none">1. Internal buffer of device is overflowed.2. Cannot find <CR> (0x0D) or \and <LF> (0x0A).3. Format of command is invalid.
E0001	<ol style="list-style-type: none">1. Unknown command (it does not P- or J-type command).2. The device failed to correctly interpret a command.
E0002	The CRC of received command (see section "the protocol extension").
K0000 0000	Request or set the parameter that does not exist.

6.4 Available parameters and its description

Action		R/W	HEX-number of parameters	
Frequency (0.1 Hz)	Value	R/W	0100	
	Minimum	R	0101	
	Maximum	R	0102	
Duration (0.1 ms)	Value	R/W	0200	
	Minimum	R	0201	
	Maximum	R	0202	
Current (0.01 A)	Value	R/W	0300	
	Minimum	R	0301	
	Maximum	R	0302	
	Measured value	R	0307	
Current set calibration (0.01%) ²	Value	R/W	030E	
Voltage (0.1 V)	Measured value	R	0407	
State of the device (bit mask)	Start (Enable)	0008h	W	0700
	Stop (Disable)	0010h		
	Internal current set	0020h		
	External current set	0040h		
	External Enable	0200h		
	Internal Enable	0400h		
	Allow Interlock	1000h		
	Deny Interlock	2000h		
	Deny NTC Interlock	4000h		
	Allow NTC Interlock	8000h		
State of the device (bit mask)	0 bit	1 – Device is powered on (always = 1)	R	0700
	1 st bit	0 – Stopped; 1 – Started		
	2 nd bit	Current set: 0 – External; 1 – Internal		
	4 th bit	Enable: 0 – External; 1 – Internal		
	6 th bit	External NTC Interlock: 0 – Allowed; 1 – Denied		
	7 th bit	Interlock: 0 – Allowed; 1 – Denied		
Serial number	Return the hex-value of the serial number	R	0701	



² Default – 100.00% (2710h), calibration range is from 95.00% (251Ch) to 105.00% (2904h).

Information about the purpose and possibilities of the device	Type of device 0-3 bits	5 – CW driver 6 – pulse driver	R	0702
	Appointment 4-7 bits	1 – Independent unit		
	Flags 8-11	8 – supports RS-232 9 – supports USB 10 – supports LAN 11 – supports TEC		
Information about parameters that you can change (bit mask)	0 bit	1 – the device supports this option	R	0703
	1 st bit	Frequency		
	2 nd bit	Duration		
	3 rd bit	Current		
Lock status (bit mask)*	0 bit	Reserve	R	0800
	1 st bit	Interlock		
	3 rd bit	Over current		
	4 th bit	Overheat (warning)		
	5 th bit	External NTC Interlock		
NTC sensor temperature (0.1°)	Lower limit		R/W	0A05
	Upper limit		R/W	0A06
	Measured value		R	0AE4
	B _{25/100}		R/W	0B0E

*If temperature of the device reaches the over temperature warning threshold the overheat flag will be set. If the device is in over temperature protection state, then it will be set overheat and over current flags together.



7. Digital control description (extended)

WARNING! Extended protocol is recommended for advanced users only. In addition, it might be useful for integration of the device with other devices.

Use the parameter number 0704h to configure the extended protocol. In extended protocol, you can enable and disable the next options: checksum (CRC 8-bit CCITT), return a new value of parameter after P-type commands, change baud-rate, change protocol-mode (text-plain or binary).

The description of the protocol extension command:



The description of the protocol extension command

Action			R\ W	HEX-number of parameters
Information about the extended protocol	0 bit	1 – the device supports this option	R	0704
	1st bit	Checksum (1 – on, 0 – off)		
	2nd bit	Return a new value for P-type commands (1 – on, 0 – off)		
	3-5 bits	Baud - rate 0 – 2400 1 – 9600 2 – 10417 3 – 19200 4 – 57600 5 – 115200 (default)		
	6th bit	Data exchange mode (1 – binary, 0 –text-plain)		
Configuring of the extended protocol	On checksum (CS)	0002h ¹	W	0704
	Off checksum	0004h ¹		
	Return a new value for P-type commands	0008h ¹		
	Do not return answer for P-type commands	0010h ³		
	Set new baud-rate(baud) ⁴	0100h – 2400 0120h – 9600 0140h – 10 417 0180h – 57 600 01A0h – 115200		
	Text-plain mode on ⁵	0200h		
	Binary mode on	0400h		

³ In binary mode the specified commands are ignored by the device

⁴ Here are binary numbers

⁵ For more information, see section “binary mode”



7.1 Text-plain mode

All commands in text-plain mode should be in ASCII.

WARNING! If you enable the checksum it will change the format of commands. After <CR> symbol you will be write 2 bytes of checksum and last byte will be <LF> (0Ah – “new line” symbol). Checksum is computed for all bytes of command before checksum bytes (including<CR> symbol).

All answers of the device will also contain a checksum, including K-type and E-type answers. Checksum is computed by CRC-CCITT-8 algorithm. This is the main difference between the format of commands for the extended protocol and standard protocol.

The format of commands for enabled checksum

Number of byte	Value	Comment
1	P,J,K,E	Type of command
2-5	Number of parameter	Hex-number of value
6	'space' symbol (20h)	<i>(does not use for J and E-type commands)</i>
7-10	New value of the parameter	Hex-value of parameter <i>(does not use for J and E-type commands)</i>
11	'return carriage' symbol<CR> (0Dh)	End of value
12-13	Checksum	CRC checksum of the first 11 bytes <i>(for J and E-type commands checksum is computed for the first 6 bytes)</i> , including <CR> symbol.
14	'new line' symbol<LF> (0Ah)	End of command



7.2 Possible problems

1. The device waiting for symbol <LF>. If <LF> symbol does not receive and buffer is overflowed, then all symbols after overload will be processed as a new command. The device returns an error. In this case, it is recommended to send the <LF> symbol. The device will generate an error and clear the buffer for the next command.
2. All symbols after the <LF> symbol will be processed as a new command.

7.3 Binary mode

The binary mode has a significant difference. In this mode, data are exchanged in binary form. The length of any type of command is 8 bytes! In this mode, the next options are always enabled and you cannot disable it: return a new value of parameter for P-type commands and checksum. The format of binary mode commands is represented in the table below.

The format of binary mode commands

Number of byte	Value	Comment
1	Type of command	50h (P - ascii) – Set a new value of parameter, 4Ah(J- ascii) – Get a value of parameter, 4Bh(K-ascii) – answer of the device, 45h (E - ascii) – Error.
2-3	Number of parameter	Hex-number of parameter
4-5	Value of parameter	Hex-value of parameter. This value is STRICTLY REQUIRED in the binary mode. If this value does not make sense, it will be returned as 0000 (K or E-type commands) or you should set it field to any value (for P or J-type commands).
6	‘return carriage’ symbol<CR> (0Dh)	End of value
7	Checksum	CRC checksum of the first 11 bytes (<i>for J and E-type commands checksum is computed for the first 6 bytes</i>), including <CR> symbol.
8	‘new line’ symbol<LF> (0Ah)	End of command