

808nm 10W High Power Fiber Bundled Diode Laser K808F02MN-10.00W (Optional Product)

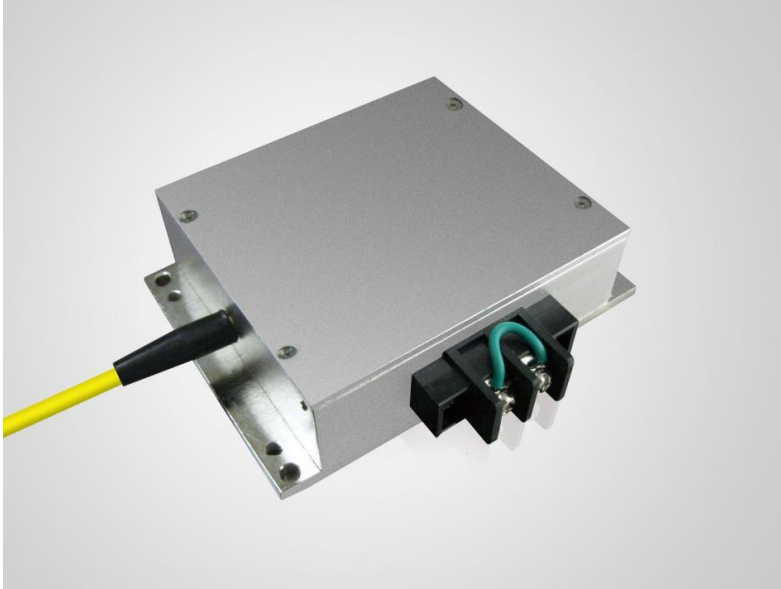

Features:

- ◆ 808nm wavelength
- ◆ 10W output power
- ◆ 400 μ m fiber core diameter
- ◆ 0.22 NA

Applications:

- ◆ Illumination
- ◆ Medical use
- ◆ Laser pumping
- ◆ Material processing

BWT Beijing's high power diode laser modules are manufactured by adopting specialized fiber-coupling techniques, resulting in volume products with a high efficiency, stability and superior beam quality. The products are achieved by transforming the asymmetric radiation from the laser diode chip into an output fiber with small core diameter by using special micro optics. Inspecting and burn-in procedures in every aspect come to a result to guarantee each product with the reliability, stability and long lifetime.

Our research staffs are constantly improving and innovating the processing technology in the producing process, based on the professional knowledge and experience accumulated in long-terms. We are also continuously developing new products to meet customers' specific needs.

At BWT Beijing, to provide high quality products with reasonable price is always our goal.

808nm 10W High Power Fiber Bundled Diode Laser K808F02MN-10.00W (Optional Product)

Specifications (25°C)		Symbol	Unit	K808F02MN-10.00W		
				Minimum	Typical	Maximum
Optical Data ⁽¹⁾	CW-Output Power	P_o	W	10	-	-
	Center Wavelength	λ_c	nm	808±10		
	Spectral Width (FWHM)	$\Delta\lambda$	nm		6	
	Wavelength Shift with Temperature	$\Delta\lambda/\Delta T$	nm/°C	-	0.3	-
	Wavelength Shift with Current	$\Delta\lambda/\Delta A$	nm/A	-	1	-
Electrical Data	Electrical-to-Optical Efficiency	PE	%	-	40	-
	Operating Current	I_{op}	A	-	-	5
	Threshold Current	I_{th}	A	-	0.8	-
	Operating Voltage	V_{op}	V	-	-	6
	Slope Efficiency	η	W/A	-	2.5	-
Fiber Data ⁽²⁾	Core Diameter	D_{core}	μm	-	400	-
	Cladding Diameter	D_{clad}	μm	-	440	-
	Numerical Aperture	NA	-	-	0.22	-
	Total Fiber Length	L_f	m	-	1.0	-
	Fiber Loose Tubing Diameter	-	mm	3mm Stainless steel		
	Minimum Bending Radius	-	mm	180	-	-
	Fiber termination	-	-	-	SMA905	-
Others	ESD	V_{esd}	V	-	-	500
	Storage Temperature ⁽²⁾	T_{st}	°C	-20	-	70
	Lead Soldering Temp	T_{is}	°C	-	-	260
	Lead Soldering Time	t	sec	-	-	10
	Operating Case Temperature ⁽³⁾	T_{op}	°C	15	-	35
	Relative Humidity	RH	%	15	-	75

(1) Data measured under operation output at 10W@25°C.

(2) A non-condensing environment is required for operation and storage.

(3) Operating temperature defined by the package case. Acceptable operating range is 15°C~35°C, but performance may vary.

808nm 10W High Power Fiber Bundled Diode Laser K808F02MN-10.00W (Optional Product)

Package Dimensions (mm)

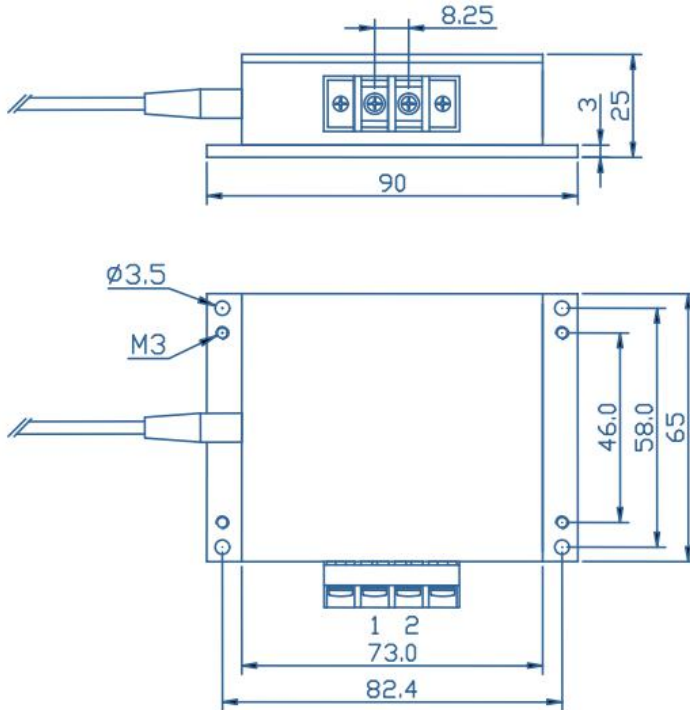

Pins	Function
1	LD (+)
2	LD (-)

OPERATING NOTES

- ◆ Avoid eye and skin exposure to direct radiation during operation.
- ◆ ESD precautions must be taken during storage, transportation and operation.
- ◆ Short-circuit is required between pins during storage and transportation.
- ◆ Please connect pins to wires by solder instead of using socket when operation current is higher than 6A. Soldering point should be close to the root of the pins. Soldering temperature should be lower than 260°C and time shorter than 10 second.
- ◆ Make sure the fiber output end is properly cleaned before operation of laser. Follow safety protocols to avoid injury when handling and cutting the fiber.
- ◆ Use constant current power supply to avoid surge current during operation.
- ◆ Laser diode must be used according to the specifications.
- ◆ Laser diode must work with good cooling.
- ◆ Operation temperature ranges from 15°C to 35°C.
- ◆ Storage temperature ranges from -20°C to +70°C.



Declaration: information and specifications contained herein are deemed to be reliable and accurate. BWT Beijing reserves the right to change, alter or modify the design and specifications of these products at any time without notice.19-1.